



SPECTRUM

SYSTEMENTWICKLUNG MICROELECTRONIC GMBH

M3i.41xx - 14 bit transient recorder up to 400 MS/s

- Up to 400 MS/s on one channel or 250 MS/s on two channels
- Simultaneously sampling on all channels
- Separate monolithic ADC and amplifier per channel
- 6 input ranges: ± 200 mV up to ± 10 V
- Up to 2 synchronous digital channels with multi-purpose I/O
- Up to 2 GSample (4 GByte) on-board memory
- 128 MSample standard memory installed
- Window, re-arm, OR/AND trigger
- Synchronization of up to 8 cards per system
- Options: Multiple Recording, Timestamps

| Speed | SNR | ENOB |
|----------|---------------|----------------|
| 100 MS/s | up to 67.7 dB | up to 11.0 LSB |
| 250 MS/s | up to 67.7 dB | up to 11.0 LSB |
| 400 MS/s | up to 65.6 dB | up to 10.6 LSB |



- 66 MHz 32 bit PCI-X interface
- 5V / 3.3V PCI compatible
- 100% compatible to conventional PCI > V2.1
- Sustained streaming mode up to 245 MB/s

- 2,5 GBit x1 PCIe Interface
- Works with x1/x4/x8/x16* PCIe slots
- Software compatible to PCI
- Sustained streaming mode up to 160 MB/s

| <u>Operating Systems</u> | <u>Recommended Software</u> | <u>Drivers</u> |
|---|--|--|
| <ul style="list-style-type: none"> • Windows 2k, XP, Vista, 7 • Linux Kernel 2.4 + 2.6 • Windows/Linux 32 and 64 bit | <ul style="list-style-type: none"> • Visual Basic, Visual C++, Borland C++ Builder, GNU C++, Borland Delphi, VB.NET, C#, J#, Python • SBench 6 | <ul style="list-style-type: none"> • MATLAB • LabVIEW • LabWindows/CVI • Agilent VEE |

| Model | 1 channel | 2 channels |
|----------|-----------|------------|
| M3i.4110 | 100 MS/s | |
| M3i.4111 | 100 MS/s | 100 MS/s |
| M3i.4120 | 250 MS/s | |
| M3i.4121 | 250 MS/s | 250 MS/s |
| M3i.4140 | 400 MS/s | |
| M3i.4142 | 400 MS/s | 250 MS/s |

General Information

The 6 models of the M3i.41xx series are designed for the fast and high quality data acquisition. Each of the input channels has its own monolithic A/D converter and its own programmable input amplifier. This allows to record signals simultaneously on both channels with 14 bit resolution without any phase delay between them. The extremely large on-board memory allows long time recording even with the highest sampling rates. All boards of the M3i.41xx series may use the whole installed on-board memory for the currently activated number of channels. A FIFO mode is also integrated on the board. This allows the acquisition of data continuously for online processing or for data storage to hard disk.

*Some x16 PCIe slots are for the use of graphic cards only and can not be used for other cards.

Software Support

Windows drivers

The cards are delivered with drivers for Windows 2000, XP, XP64, Vista and Vista64 as well as Windows 7. Programming examples for Visual C++, Borland C++ Builder, LabWindows/CVI, Borland Delphi, Visual Basic, VB.NET, C# and J# are included.

Linux Drivers



All cards are delivered with full Linux support. Pre compiled kernel modules are included for the most common distributions like RedHat, Fedora, Suse or Debian. The Linux support includes SMP systems, 32 bit and 64 bit systems, versatile programming examples for Gnu C++ as well as the possibility to get the driver sources for own compilation.

SBench 6

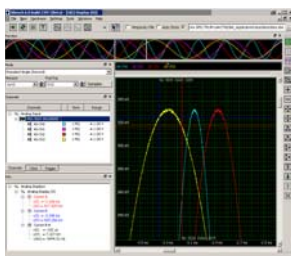

A base licence of SBench 6 the easy-to-use graphical operating software for the Spectrum cards is included in the delivery. Using the base license it is possible to test the card and to show acquired data. There are also some basic measurement functions included in the base license. The card comes with a demo license for the professional version giving the user the opportunity to test the features of the professional version with the new hardware. Existing customers have the opportunity to request a demo license for the professional version at Spectrum. The professional version contains several new measurement functions, FFT, import and export (including MATLAB and ASCII) as well as the streaming modes. The data streaming modes allow to continuously acquire data to hard disk. SBench 6 has been optimized to handle data files of several GByte. More details on SBench 6 are found in the dedicated SBench 6 data sheet. The version 6 is running under Windows as well as under Linux (KDE and GNOME). A test version of SBench 6 is freely available in the internet. This test version will also operate with demo cards and can be tested as Professional version without any hardware installed.

Third-party products

A lot of third-party products are supported as an option. Choose between LabVIEW, MATLAB and Agilent VEE. All drivers come with examples and detailed documentation.

Hardware features and options

PCI/PCI-X



The cards with PCI/PCI-X bus connector use 32 Bit and up to 66 MHz clock rate for data transfer. They are 100% compatible to Conventional PCI > V2.1. The universal interface allows the use in PCI slots with 5 V I/O and 3.3 V I/O voltages as well as in PCI-

X or PCI 64 slots. The maximum sustained data transfer rate is 245 MByte/s per bus segment.

PCI Express



The cards with PCI Express use a x1 PCIe connector. They can be used in PCI Express x1/x4/x8/x16 slots, except special graphic card slots, and are 100% software compatible to

Conventional PCI > V2.1. The maximum sustained data transfer rate is 160 MByte/s per slot.

SMA connectors



As an alternative to the standard SMB and MMCX connections the card can also be equipped with SMA connectors. The SMA connections are available for the analog input signals as well as for two of the additional connections. These connections must be defined on the purchase order and can be a selection of: Trig-In, Trig-Out, Multi-Purpose X0, Clk-In, Clk-Out.

Input Amplifier

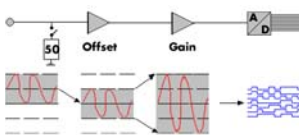

The analog inputs can be adapted to real world signals using a wide variety of settings that are individual for each channel. By using software commands the input termination can be changed between 50 Ohm and 1 MOhm, one can select a matching input range and the signal offset can be compensated by programmable AC coupling.

Software selectable input path

For each of the analog channels the user has the choice between two analog input paths. The „Buffered“ path offers the highest flexibility when it comes to input ranges and termination. A software programmable 50 Ohm and 1 MOhm termination also allows to connect standard oscilloscope probes to the card. The „50 Ohm“ path on the other hand provides the highest bandwidth and the best signal integrity with a fewer number of input ranges and a fixed 50 Ohm termination.

Software selectable lowpass filter

Each analog channel contains a software selectable low-pass filter to limit the input bandwidth. Reducing the analog input bandwidth results in a lower total noise and can be useful especially with low voltage input signals.

Automatic on-board calibration

All of the channels are calibrated in factory before the board is shipped. To compensate for different variations like PC power supply, temperature and aging, the software driver provides routines for an automatic onboard offset and gain calibration of all input ranges of the „Buffered“ path. All the cards contain a high precision on-board calibration reference.

Digital inputs

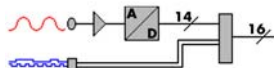

This option acquires additional synchronous digital channels phase-stable with the analog data. A maximum of 2 additional digital inputs are available on the front plate of the card using the multi-purpose I/O lines.

Ring buffer mode

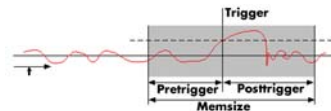

The ring buffer mode is the standard mode of all oscilloscope boards. Data is written in a ring memory of the board until a trigger event is detected. After the event the posttrigger values are recorded. Because of this continuously recording into a ring buffer there are also samples prior to the trigger event visible: Pretrigger = Memsize - Posttrigger.

FIFO mode

The FIFO mode is designed for continuous data transfer between measurement board and PC memory (up to 245 MB/s on a PCI-X

slot, up to 125 MB/s on a PCI slot and up to 160 MB/s on a PCIe slot) or hard disk. The control of the data stream is done automatically by the driver on interrupt request. The complete installed on-board memory is used for buffer data, making the continuous streaming extremely reliable.

Channel trigger

The data acquisition boards offer a wide variety of trigger modes. Besides the standard signal checking for level and edge as known from oscilloscopes it's also possible to define a window trigger. All trigger modes can be combined with a re-arming mode (for accurate trigger recognition on noisy signals) the AND/OR conjunction of different trigger events is possible.

External trigger input

All boards can be triggered using an external analog or digital signal. It's possible to use positive or negative edge. As two analog comparators are used, one can also define a window trigger, a hysteresis trigger or a re-arm trigger.

Universal Multi-Purpose I/Os



All M3i cards offer two universal multi-purpose I/O lines, which can be separately programmed as either input or output. These lines can be used as additional TTL trigger inputs for more complex trigger conditions. Additionally these lines can also be used to acquire digital data synchronously with the analog data (see Digital Inputs). When used as outputs, these lines can be used to output card status signals like trigger-armed or to output the trigger to synchronize external equipment.

Multiple Recording

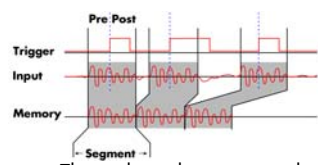

The Multiple Recording option allows the recording of several trigger events with an extremely short re-arming time. The hardware doesn't need to be restarted in between.

The on-board memory is divided in several segments of the same size. Each of them is filled with data if a trigger event occurs. Pre- and posttrigger of the segments can be programmed. The number of acquired segments is only limited by the used memory and is unlimited when using FIFO mode.

ABA mode

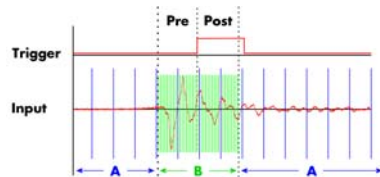

The optional ABA mode combines slow continuous data recording with fast acquisition on trigger events. The ABA mode works like a slow data logger combined with a fast digitizer. The exact position of the trigger events is stored as timestamps in an extra memory.

The exact position of the trigger events is stored as timestamps in an extra memory.

Timestamp

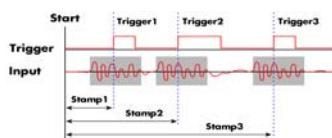

The timestamp option writes the time positions of the trigger events in an extra memory. The timestamps are relative to the start of recording, a defined zero time, externally synchronised to a radio clock, or a GPS receiver. With this option acquisitions of systems on different locations can be set in a precise time relation.

With this option acquisitions of systems on different locations can be set in a precise time relation.

External clock input and output

Using a dedicated connector a sampling clock can be fed in from an external system. Additionally it's also possible to output the internally used sampling clock on a separate connector to synchronize external equipment to this clock.

Reference clock

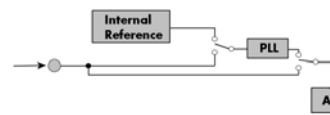

The option to use a precise external reference clock (normally 10 MHz) is necessary to synchronize the board for high-quality measurements with external equipment (like a signal source). It's also possible to enhance the quality of the sampling clock in this way. The driver automatically generates the requested sampling clock from the fed in reference clock.

Star-Hub



The star-hub is an additional module allowing the phase stable synchronisation of up to 8 boards of a kind in one system. Independent of the number of boards there is no phase delay between all channels. The star-hub distributes trigger and clock information between all boards. As a result all connected boards are running with the same clock and the same trigger. All trigger sources can be combined with a logical OR allowing all channels of all cards to be trigger source at the same time.

BaseXIO (enhanced timestamps)



The BaseXIO option offers 8 asynchronous digital I/O lines on the base card, which are available on a separate bracket as SMB connectors. The direction can be selected by software in groups of four.

In addition one of the I/O lines can be used as reference clock for the Timestamp counter.

External Amplifiers



For the acquisition of extremely small voltage levels with a high bandwidth a series of external amplifiers is available. Each of the one channel amplifiers is working with a fixed input impedance and allows - depending on the bandwidth - to select different amplification levels between x10 (20 dB) up to

x1000 (60 dB). Using the external amplifiers of the SPA series voltage levels in the μV and mV area can be acquired.

Technical Data

Analog Inputs

| | |
|------------------------------------|------------------------------------|
| Resolution | 14 bit |
| Differential non linearity (DNL) | ≤ 1.5 LSB (ADC, $f_{in} = 70$ MHz) |
| Integral non linearity (INL) | ≤ 3 LSB (ADC, $f_{in} = 70$ MHz) |
| Programmable input offset | not available |
| Connector (analog inputs) | 3 mm SMB male |
| Crosstalk sine signal ±1V @ 1 MOhm | 1 MHz: <-100dB, 20 MHz <-95 dB |
| Crosstalk sine signal ±5V @ 1 MOhm | 1 MHz: <-77 dB, 20 MHz <-73 dB |
| Crosstalk sine signal ±5V @ 50 Ohm | 1 MHz: <-100dB, 20 MHz <-100 dB |
| 20 MHz BW Filter Characteristics | 3rd order Butterworth |

Input Path

| | 50 ohm path 1 | Buffered path 0 |
|--|-----------------------------|---|
| Input impedance | fixed 50 Ohm | 50 Ohm, 1 MOhm 25 pF |
| Max input @ 50 Ohm (> ±1 V range) | 6 Vrms | 5 Vrms |
| Max input @ 50 Ohm (≤ ±1 V range) | 2 Vrms | 5 Vrms |
| Max input @ 1 MOhm (> ±1 V range) | n.a. | ±30 V |
| Max input @ 1 MOhm (≤ ±1 V range) | n.a. | ±5 V |
| Max DC voltage if AC coupling active | ±30 V DC level | ±30 V DC level |
| Relative input stage delay | 0 ns | 3.8 ns |
| Input ranges | ±500 mV, ±1 V, ±2.5 V, ±5 V | ±200 mV, ±500 mV, ±1 V, ±2 V, ±5 V, ±10 V |
| Offset Error after warm-up + calibration | ≤0.1% of range | ≤0.1% of range |
| Gain Error after warm-up + calibration | ≤1.0% of range | ≤0.1% of range |

Trigger

| | |
|--|---|
| Multiple Recording: re-arming time | ≤ 32 Samples |
| Max Pretrigger at standard mode | up to full memsize |
| Max Pretrigger at Multi and FIFO | 8192 Samples as sum of all active channels |
| Internal trigger accuracy | 1 Sample |
| Channel trigger resolution | 10 bits |
| Trigger output delay | 134 sampling clock cycles (after trigger input) |
| External trigger type (Ext0) | Analog window comparator |
| Programmable trigger levels (Ext0) | 2 levels +/- 5V in steps of 1 mV |
| Minimum trigger pulse width | ≥ 2 clock periods |
| Ext. trigger connector (Ext0) | MMCX female |
| Ext. trigger max voltage 1 MOhm (Ext0) | ±30 V |
| Ext. trigger max voltage 50 Ohm (Ext0) | 5V rms |
| Ext. trigger impedance (Ext0) | 50 Ohm / 1 MOhm 25 pF |
| External trigger accuracy (All) | 1 Sample |
| Trigger output | see multi purpose I/O lines below |

Power consumption (max speed)

| | PCI / PCI-X | | PCI EXPRESS | |
|------------------------------------|-------------|-------|-------------|-------|
| | 3,3 V | 5 V | 3,3 V | 12 V |
| M3i.41x0 (128 MS memory) | 2.4 A | 1.7 A | 0.4 A | 1.4 A |
| M3i.41x1 (128 MS memory) | 2.9 A | 2.0 A | 0.4 A | 1.8 A |
| M3i.41x2 (128 MS memory) | 2.9 A | 2.0 A | 0.4 A | 1.9 A |
| M3i.41x2 (2 GS memory), max. power | 3.0 A | 3.0 A | 0.4 A | 2.6 A |

Max channels with Star-Hub

| | SH4 | SH8 |
|----------|-----|-----|
| M3i.41x0 | 4 | 8 |
| M3i.41x1 | 8 | 16 |

BaseXIO (Option)

| | |
|-----------------------------------|---|
| BaseXIO Connector (extra bracket) | 8 x SMB male (8 x MMCX female internal) |
| BaseXIO input | TTL compatible: Low ≤ 0.8 V, High ≥ 2.0 V |
| BaseXIO input impedance | 4.7 kOhm towards 3.3 V |
| BaseXIO input maximum voltage | -0.5 V up to +5.5 V |
| BaseXIO output levels | TTL compatible: Low ≤ 0.4 V, High ≥ 2.4 V |
| BaseXIO output drive strength | 32 mA maximum current |

Multi purpose digital I/O

| | |
|--|--|
| No of multi purpose lines | two: (X0 = Ext1), (X1 = Ext2) |
| Connector Type | MMCX female |
| Input: available input signals | Additional TTL trigger, digital input, async input |
| Input: input impedance | 10 k towards 3.3 V |
| Input: digital-in delay to analog sample | 0 Samples (>250 MS/s: -3 samples) |
| Input: maximum voltage | -0.3 V up to +5.5 V |
| Input: input voltage level | Low ≤ 0.8 V, High ≥ 2.0 V |
| Input: minimum pulse width | ≥ 2 clock periods |
| Output: available output signals | trigger, overrange, arm, run, async output |
| Output: output impedance | 50 Ohm |
| Output: output levels | Low ≤ 0.4 V, High ≥ 2.4 V |
| Output: output type | TTL compatible for high-impedance loads |
| Output: output drive strength | Capable of driving 50 Ohm load |

Clock

| | |
|--|--|
| Internal clock range | 9 MHz to max (see table below) |
| Internal clock accuracy | max. ± 32 ppm |
| Internal clock setup granularity | 1 Hz |
| Clock range gaps (internal and external) | 70 to 72, 140 to 144, 281 to 287 MHz |
| External clock input connector/coupling | MMCX female, AC coupled |
| External clock input termination | 50 Ohm fixed |
| Reference clock: external clock range | ≥ 10.0 MHz and ≤ 1.0 GHz |
| Sampling clock from ref clock range | 9 MHz to max (see table below) |
| Sampling clock from ref clock granularity | 1 kHz |
| External clock delay to internal ADC clock | 3.7 ns (8.2 ns at synchronized cards) |
| External clock input type | single-ended, sine wave or square wave |
| External clock min input swing | 0.3 V peak peak |
| External clock maximum voltage | 3.0 V peak peak |
| External clock duty cycle requirement | 40% to 60% |
| External clock output connector/coupling | MMCX female, AC coupled |
| External clock output type | single-ended, 3.3V LVPECL |
| External clock output drive strength | Capable of driving 50 ohm load |

Environmental and Physical details

| | |
|----------------------------------|--------------------------------------|
| Dimension (PCB only) | 312 mm x 107 mm (full PCI length) |
| Width (Standard or star-hub 4) | 1 full size slot |
| Width (star-hub 8) | 2 full size slots |
| Width (with BaseXIO) | 1 full size slots + 1 half size slot |
| Weight (plain card) | 320 g |
| Weight (plain card + option SH4) | 380 g |
| Weight (plain card + option SH8) | 400 g |
| Warm up time | 10 minutes |
| Operating temperature | 0°C - 50°C |
| Storage temperature | -10°C - 70°C |
| Humidity | 10% to 90% |

PCI / PCI-X specific details

| | |
|------------------------------------|--|
| PCI / PCI-X bus slot type | 32 bit 33/66 MHz |
| PCI / PCI-X bus slot compatibility | 32/64 bit, 33-133 MHz, 3,3 and 5 V I/O |

PCI EXPRESS specific details

| | |
|-------------------------|---------------|
| PCIe slot type | x1 |
| PCIe slot compatibility | x1/x4/x8/x16* |

*Some x16 PCIe slots are for graphic cards only and can not be used for other cards.

Software programmable parameters

| | |
|-----------------------------------|---|
| Input Ranges (Buffered path) | ±200mV, ±500mV, ±1V, ±2V, ±5V, ±10V |
| Input Ranges (50 Ohm path) | ±500mV, ±1V, ±2.5V, ±5V |
| Analog input impedance | 50 Ohm / 1M Ohm (Buffered path) |
| Analog input coupling | AC / DC |
| Analog bandwidth limit filter | on/off |
| Clock mode | Internal, external reference clock, sync |
| Trigger mode | Ch0, Ch1, Ext0(Analog), Ext1/2(TTL), SW |
| Enhanced trigger | Window, Re-Arm, Or/And, Delay |
| Trigger level (channel) | 10 bit resolution relating to input range |
| Trigger level (Ext0) | 1 mV resolution: -5000 mV to +5000 mV |
| Trigger edge (channel + external) | Rising edge, falling edge or both edges |
| Trigger delay | 0 to 32G samples in steps of 8 samples |
| External trigger (Ext0) coupling | AC/DC |
| External trigger (Ext0) impedance | 50 Ohm / 1M Ohm |
| Memory depth | 16 up to [installed memory / number of active channels] in steps of 8 |
| Posttrigger | 8 up to 4 GSamples in steps of 8 |
| Multiple Recording segment size | 16 up to [installed memory / 2 / active channels] in steps of 16 |
| Multiple Recording pretrigger | 8 up to [8k samples / number of active channels] |

Certifications, Compliances, Warranty

| | |
|-------------------------------|---|
| EMC Immunity | Compliant with CE Mark |
| EMC Emission | Compliant with CE Mark |
| Product warranty | 2 years starting with the day of delivery |
| Software and firmware updates | Life-time, free of charge |

Option SMA connectors

| | |
|------------------------------|--|
| Available signals for SMA XA | One of Trig-In, Trig-Out, Multi Purpose X0 |
| Available signals for SMA XB | One of Clk-In, Clk-Out, Trig-In |

| | M3i.4110 | M3i.4111 | M3i.4120 | M3i.4121 | M3i.4140 | M3i.4142 |
|--|----------|----------|----------|----------|----------|----------|
| max internal clock (1 channel active) | 100 MS/s | 100 MS/s | 250 MS/s | 250 MS/s | 400 MS/s | 400 MS/s |
| max internal clock (2 channels active) | n.a. | 100 MS/s | n.a. | 250 MS/s | n.a. | 250 MS/s |
| lower bandwidth limit (DC coupling) | 0 Hz | 0 Hz | 0 Hz | 0 Hz | 0 Hz | 0 Hz |
| lower bandwidth limit (AC coupled, 50 Ohm) | <30 kHz | <30 kHz | <30 kHz | <30 kHz | <30 kHz | <30 kHz |
| lower bandwidth limit (AC coupled, 1 MOhm) | <2 Hz | <2 Hz | <2 Hz | <2 Hz | <2 Hz | <2 Hz |
| -3 dB bandwidth (buffered path) | 50 MHz | 50 MHz | 90 MHz | 90 MHz | 125 MHz | 125 MHz |
| -3 dB bandwidth (50 ohm path) | 50 MHz | 50 MHz | 125 MHz | 125 MHz | 200 MHz | 200 MHz |
| -3 dB bandwidth (BW limit enabled) | 20 MHz | 20 MHz | 20 MHz | 20 MHz | 20 MHz | 20 MHz |

Dynamic Parameters

| M3i.4142 and M3i.4140, 1 channel 400 MS/s | | | | | | | | | | | | |
|---|-----------------------------------|-------|-------|--------|--------|-------|-------------------------|--------|-------|------------------------|--------|-------|
| Input Path | HF path, AC coupled, fixed 50 Ohm | | | | | | Buffered path, BW limit | | | Buffered path, full BW | | |
| Test signal frequency | 9 MHz | | | 40 MHz | 70 MHz | 9 MHz | | | 9 MHz | 40 MHz | 70 MHz | |
| Input Range | ±500mV | ±1V | ±2.5V | ±5V | ±1V | ±1V | ±200mV | ±500mV | ±1V | ±1V | ±1V | ±1V |
| RMS Noise (zero level) | < 3.3 LSB | | | | | | < 3.5 LSB | | | < 6.3 LSB | | |
| THD (typ) (dB) | -80.9 | -81.1 | -79.9 | -75.9 | -76.1 | -64.9 | -72.1 | -75.0 | -71.1 | -65.3 | -55.5 | -51.7 |
| SNR (typ) (dB) | 65.0 | 65.6 | 65.1 | 65.6 | 65.6 | 65.4 | 65.7 | 66.0 | 66.5 | 64.0 | 62.3 | 61.9 |
| SFDR (typ), excl. harm. (dB) | 82.1 | 84.3 | 82.3 | 84.2 | 82.7 | 76.5 | 82.2 | 80.1 | 82.3 | 81.6 | 77.9 | 74.3 |
| SFDR (typ), incl. harm. (dB) | 82.0 | 84.3 | 81.7 | 77.1 | 78.1 | 65.8 | 75.1 | 78.0 | 73.1 | 66.5 | 58.8 | 54.8 |
| SINAD/THD+N (typ) (dB) | 64.9 | 65.5 | 65.0 | 65.3 | 65.3 | 62.4 | 64.9 | 65.8 | 65.5 | 61.7 | 54.9 | 51.5 |
| ENOB based on SINAD (bit) | 10.5 | 10.6 | 10.5 | 10.6 | 10.6 | 10.1 | 10.5 | 10.6 | 10.6 | 10.0 | 8.8 | 8.3 |
| ENOB based on SNR (bit) | 10.5 | 10.6 | 10.6 | 10.6 | 10.6 | 10.6 | 10.6 | 10.6 | 10.7 | 10.4 | 10.1 | 10.0 |

| M3i.4121 and M3i.4120, 1 or 2 channels 250 MS/s | | | | | | | | | | | | |
|---|-----------------------------------|-------|-------|--------|--------|-------|-------------------------|--------|-------|------------------------|--------|-------|
| Input Path | HF path, AC coupled, fixed 50 Ohm | | | | | | Buffered path, BW limit | | | Buffered path, full BW | | |
| Test signal frequency | 9 MHz | | | 40 MHz | 70 MHz | 9 MHz | | | 9 MHz | 40 MHz | 70 MHz | |
| Input Range | ±500mV | ±1V | ±2.5V | ±5V | ±1V | ±1V | ±200mV | ±500mV | ±1V | ±1V | ±1V | ±1V |
| RMS Noise (zero level) | < 2.2 LSB | | | | | | < 2.5 LSB | | | < 3.4 LSB | | |
| THD (typ) (dB) | -81.2 | -80.2 | -76.1 | -74.0 | -82.8 | -73.9 | -69.5 | -75.1 | -71.1 | -66.0 | -57.0 | -53.4 |
| SNR (typ) (dB) | 67.5 | 67.7 | 67.2 | 67.6 | 67.7 | 67.4 | 67.1 | 67.6 | 67.8 | 66.7 | 66.6 | 66.6 |
| SFDR (typ), excl. harm. (dB) | 84.3 | 83.8 | 83.6 | 83.7 | 83.6 | 74.5 | 87.4 | 87.4 | 87.1 | 81.0 | 80.7 | 79.8 |
| SFDR (typ), incl. harm. (dB) | 84.2 | 83.0 | 77.5 | 74.5 | 83.5 | 74.4 | 70.1 | 76.5 | 74.2 | 67.1 | 59.6 | 54.3 |
| SINAD/THD+N (typ) (dB) | 67.3 | 67.4 | 66.7 | 66.7 | 67.6 | 66.6 | 65.1 | 66.9 | 66.3 | 63.4 | 56.6 | 53.2 |
| ENOB based on SINAD (bit) | 10.9 | 10.9 | 10.8 | 10.8 | 10.9 | 10.8 | 10.6 | 10.8 | 10.7 | 10.3 | 9.1 | 8.6 |
| ENOB based on SNR (bit) | 10.9 | 11.0 | 10.9 | 10.9 | 11.0 | 10.9 | 10.9 | 11.0 | 11.0 | 10.8 | 10.8 | 10.8 |

| M3i.4111 and M3i.4110, 1 or 2 channels 100 MS/s | | | | | | | | | | | | |
|---|-----------------------------------|-------|-------|--------|--------|-------|-------------------------|--------|-------|------------------------|--------|------|
| Input Path | HF path, AC coupled, fixed 50 Ohm | | | | | | Buffered path, BW limit | | | Buffered path, full BW | | |
| Test signal frequency | 9 MHz | | | 40 MHz | 70 MHz | 9 MHz | | | 9 MHz | 40 MHz | 70 MHz | |
| Input Range | ±500mV | ±1V | ±2.5V | ±5V | ±1V | ±1V | ±200mV | ±500mV | ±1V | ±1V | ±1V | ±1V |
| RMS Noise (zero level) | < 2.2 LSB | | | | | | < 2.5 LSB | | | < 3.0 LSB | | |
| THD (typ) (dB) | -80.0 | -78.6 | -77.5 | -76.9 | n.a. | n.a. | -67.8 | -73.5 | -69.5 | -66.5 | n.a. | n.a. |
| SNR (typ) (dB) | 67.6 | 67.7 | 67.4 | 67.6 | n.a. | n.a. | 66.5 | 67.3 | 67.0 | 66.9 | n.a. | n.a. |
| SFDR (typ), excl. harm. (dB) | 84.5 | 84.2 | 84.0 | 84.4 | n.a. | n.a. | 84.3 | 84.4 | 84.3 | 84.7 | n.a. | n.a. |
| SFDR (typ), incl. harm. (dB) | 83.6 | 82.0 | 82.8 | 80.6 | n.a. | n.a. | 68.0 | 76.3 | 72.1 | 67.2 | n.a. | n.a. |
| SINAD/THD+N (typ) (dB) | 67.3 | 67.3 | 66.9 | 66.9 | n.a. | n.a. | 64.0 | 66.4 | 64.9 | 63.3 | n.a. | n.a. |
| ENOB based on SINAD (bit) | 10.9 | 10.9 | 10.9 | 10.8 | n.a. | n.a. | 10.3 | 10.7 | 10.5 | 10.2 | n.a. | n.a. |
| ENOB based on SNR (bit) | 10.9 | 11.0 | 10.9 | 10.8 | n.a. | n.a. | 10.7 | 10.9 | 10.9 | 10.8 | n.a. | n.a. |

A pure sine wave with > 99% amplitude of input range is measured with 50 ohms termination. SNR and RMS noise parameters may differ depending on the quality of the used PC. SNR = Signal to Noise Ratio, THD = Total Harmonic Distortion, SFDR = Spurious Free Dynamic Range, SINAD = Signal Noise and Distortion, ENOB = Effective Number of Bits. For a detailed description please see application note 002.

Hardware block diagram

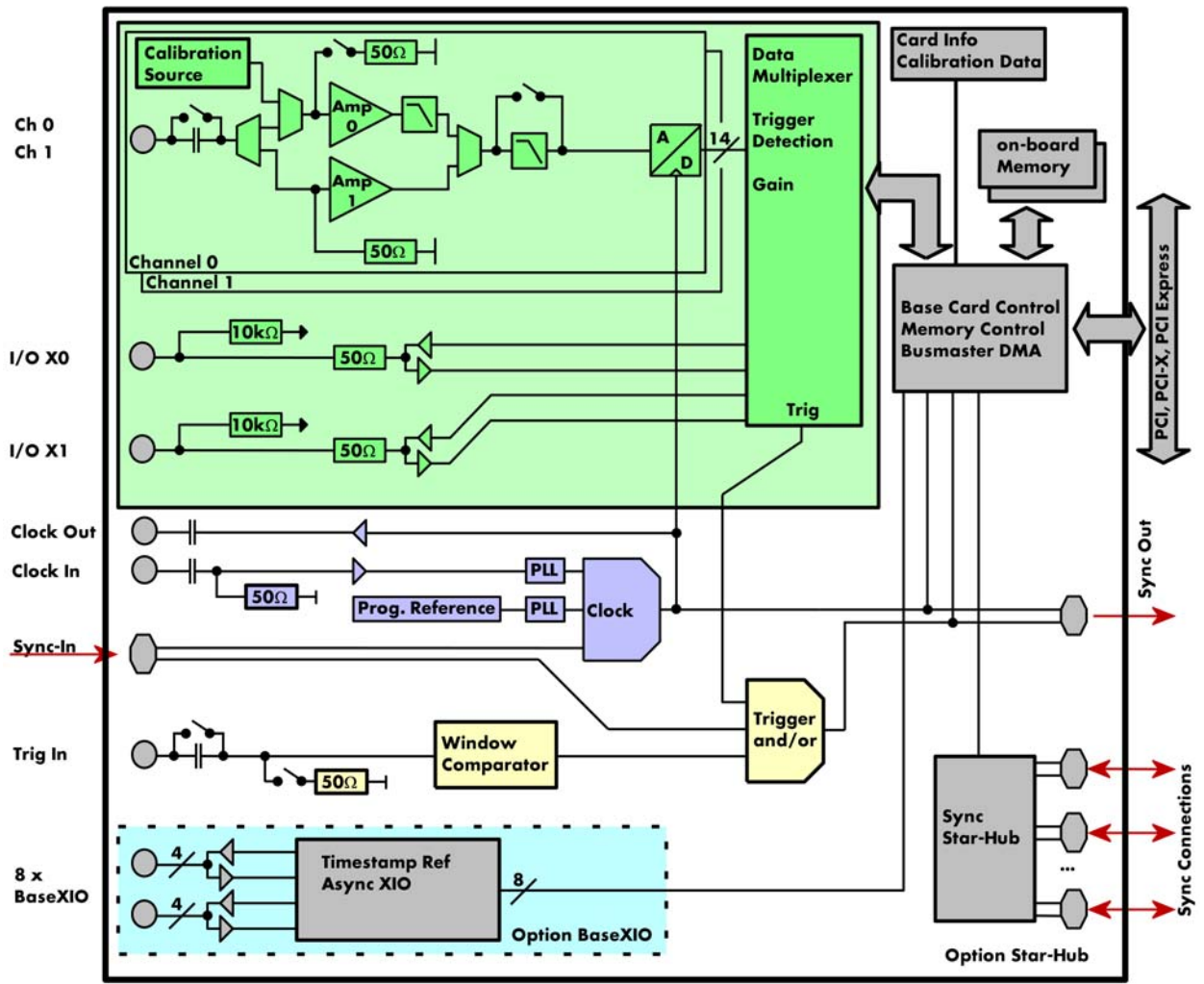

Order Information

| PCI/PCI-X | Order no. | Standard mem | 1 channel | 2 channels |
|------------------|-----------|--------------|-----------|------------|
| | M3i.4110 | 128 MSample | 100 MS/s | |
| | M3i.4111 | 128 MSample | 100 MS/s | 100 MS/s |
| | M3i.4120 | 128 MSample | 250 MS/s | |
| | M3i.4121 | 128 MSample | 250 MS/s | 250 MS/s |
| | M3i.4140 | 128 MSample | 400 MS/s | |
| | M3i.4142 | 128 MSample | 400 MS/s | 250 MS/s |

| PCI Express | Order no. | Standard mem | 1 channel | 2 channels |
|--------------------|--------------|--------------|-----------|------------|
| | M3i.4110-exp | 128 MSample | 100 MS/s | |
| | M3i.4111-exp | 128 MSample | 100 MS/s | 100 MS/s |
| | M3i.4120-exp | 128 MSample | 250 MS/s | |
| | M3i.4121-exp | 128 MSample | 250 MS/s | 250 MS/s |
| | M3i.4140-exp | 128 MSample | 400 MS/s | |
| | M3i.4142-exp | 128 MSample | 400 MS/s | 250 MS/s |

| Memory | Order no. | Option |
|---------------|----------------|---|
| | M3i.xxxx-256MS | Memory upgrade to 256 MSample (512 MB) total memory |
| | M3i.xxxx-512MS | Memory upgrade to 512 MSample (1 GB) total memory |
| | M3i.xxxx-1GS | Memory upgrade to 1 GSsample (2 GB) total memory |
| | M3i.xxxx-2GS | Memory upgrade to 2 GSsample (4 GB) total memory |

| Options | Order no. | Option |
|----------------|---------------|--|
| | M3i.xxxx-mr | Option Multiple Recording |
| | M3i.xxxx-mt | Option pack including Multiple Recording, Timestamp |
| | M3i.xxxx-mtab | Option pack including Multiple Recording, Timestamp, ABA mode |
| | M3i.xxxx-SH4 | Synchronization Star-Hub for up to 4 cards, only 1 slot width |
| | M3i.xxxx-SH8 | Synchronization Star-Hub for up to 8 cards, 2 slots width |
| | M3i.xxxx-bxio | Option BaseXIO: 8 digital I/O lines usable as asynchronous I/O and timestamp ref-clock, additional bracket with 8 SMB connectors |
| | M3i.xxxx-SMA | Option SMA connections for analog inputs + two signals of Clock-In, Clock-Out, Trig-In, Trig-Out, X0 |
| | M3i-upgrade | Upgrade for M3i.xxxx: later installation of option -bxio or SMA connectors |

| Cables | for Connections | Connection | Length | Order no. | to BNC male | to BNC female | to SMA male | to SMA female |
|---------------|---------------------|------------|--------|----------------|-------------|----------------|----------------|----------------|
| | Standard inputs | SMB female | 80 cm | Cab-3f-9m-80 | | Cab-3f-9f-80 | Cab-3f-3mA-80 | Cab-3f-3fA-80 |
| | Standard inputs | SMB female | 200 cm | Cab-3f-9m-200 | | Cab-3f-9f-200 | Cab-3f-3mA-200 | Cab-3f-3fA-200 |
| | Probes (short) | SMB female | 5 cm | | | Cab-3f-9f-5 | | |
| | Trigger/Clock/Extra | MMCX male | 80 cm | Cab-1m-9m-80 | | Cab-1m-9f-80 | Cab-1m-3mA-80 | Cab-1m-3fA-80 |
| | Trigger/Clock/Extra | MMCX male | 200 cm | Cab-1m-9m-200 | | Cab-1m-9f-200 | Cab-1m-3mA-200 | Cab-1m-3fA-200 |
| | SMA Option | SMA male | 80 cm | Cab-3mA-9m-80 | | Cab-3mA-9f-80 | | |
| | SMA Option | SMA male | 200 cm | Cab-3mA-9m-200 | | Cab-3mA-9f-200 | | |

| Amplifiers | Order no. | Bandwidth | Input Impedance | Coupling | Amplification |
|-------------------|-----------------|--|-----------------|----------|-----------------------|
| | SPA.1601 (2) | 500 MHz | 50 Ohm | DC | x10 (20 dB) |
| | SPA.1412 (2) | 200 MHz | 1 MOhm | AC/DC | x10/x100 (20/40 dB) |
| | SPA.1411 (2) | 200 MHz | 50 Ohm | AC/DC | x10/x100 (20/40 dB) |
| | SPA.1232 (2) | 10 MHz | 1 MOhm | AC/DC | x100/x1000 (40/60 dB) |
| | SPA.1231 (2) | 10 MHz | 50 Ohm | AC/DC | x100/x1000 (40/60 dB) |
| | SPA.PW1-120 (2) | External power supply for all SPA amplifiers with 120 VAC, type A (US, Japan) connector | | | |
| | SPA.PW1-230 (2) | External power supply for all SPA amplifiers with 230 VAC, type C (European) connector | | | |
| | Information | External Amplifiers with one channel, BNC connections, manually adjustable offset, manually switch between settings. A power supply need to be ordered for each amplifier! | | | |

| Drivers | Order no. | Option |
|----------------|--------------|--|
| | M3i.xxxx-ml | MATLAB driver for all M3i and M3i Express cards |
| | M3i.xxxx-lv | LabVIEW driver for all M3i and M3i Express cards |
| | M3i.41xx-vee | Agilent VEE driver for all M3i.41xx cards |

| SBench6 | Order no. | |
|----------------|-----------------|---|
| | SBench6 | Base version which support standard mode for one card |
| | SBench6-Pro | Professional version for one card: FIFO mode, export/import, calculation functions |
| | SBench6-Multi | Option multiple cards: needs Professional version. Handles multiple synchronized cards in one system. |
| | Volume Licenses | Please ask Spectrum for details. |

(1) : Just one of the options can be installed on a card at a time.

(2) : Third party product with warranty differing from our export conditions. No volume rebate possible.

Technical changes and printing errors possible